



Shower fittings. By SCHELL.

SCHELL.

If you see SCHELL, you can expect high quality.



Plant 1
Production with administration building and training centre

Developed especially to cope with the demands of public sanitary facilities: fittings from SCHELL.



When installing fittings in shower rooms, aspects such as saving water, robustness and hygiene play an important role – especially in public, semi-public and commercial sanitary facilities. SCHELL gives you peace of mind. After all, our name has been synonymous with intelligent, “Made in Germany” valve technology for nearly 90 years. SCHELL offers you a full range of technical solutions for concealed and wall-mounted installation, uncompromising quality and the appropriate modules for wall mounting.

Discover everything that our products have to offer. If you have any queries regarding our shower solutions, simply give us a call. We are more than happy to help.

Phone +49 2761 892-0
www.schell.eu | info@schell.eu

SCHELL is a member of the following initiatives



More information at:
www.blue-responsibility.com



Table of contents

| | |
|------------------------------------------------------------|----------------|
| SCHELL <i>inside.</i> | Page 4 |
| SCHELL SWS | Page 8 |
| Intelligent water management | Page 8 |
| Concealed solutions | Page 10 |
| LINUS shower fittings system overview | Page 10 |
| <i>Manual actuation via self-closing cartridge</i> | <i>Page 12</i> |
| LINUS Basic D-SC-M/LINUS Basic D-SC-T | Page 13 |
| LINUS D-SC-T/LINUS D-SC-M/LINUS D-SC-V | Page 15 |
| <i>CVD touch electronics</i> | <i>Page 16</i> |
| <i>(actuation via solenoid valve)</i> | |
| LINUS D-C-T/LINUS Basic D-C-T/LINUS D-C-M | Page 17 |
| LINUS Basic D-C-M/LINUS Basic D-C-V | |
| LINUS concealed shower fittings product overview | Page 18 |
| Exposed solutions and shower panels | Page 20 |
| Features of VITUS shower fittings | Page 21 |
| VITUS shower fittings product overview | Page 22 |
| VITUS shower fittings system overview | Page 23 |
| <i>VITUS accessories</i> | <i>Page 24</i> |
| <i>Exposed shower fittings (via self-closing cartridge</i> | <i>Page 26</i> |
| <i>or CVD touch electronics with solenoid valve)</i> | |
| LINUS DP-C-T/LINUS DP-SC-T/LINUS DP-SC-M/LINUS DP-SC-V | Page 27 |
| LINUS DP-EH-M | |
| References | Page 31 |



SCHELL *inside.*

Schell supplies robust, hygienic and resource-efficient solutions wherever they are needed – such as in public, semi-public and commercial sanitary facilities. Just some of the places where our solutions are found worldwide include:

- Schools
- Nursery schools
- Hotels
- Food industry
- Hospitals
- Residential nursing homes
- Manufacturing
- Public administration
- Airports
- Railway stations
- Motorway service stations
- Leisure facilities
- Sports facilities
- Swimming pools



WC flush systems

SCHELL meets the most stringent demands with its comprehensive range of water-saving and hygienic WC flushing systems. These include flush fittings for exposed installation, concealed installation solutions and concealed cisterns. These can be operated either mechanically or electronically. All in all, these are an ideal set of features for both simple and speedy retrofitting in renovation projects and for new-build projects. A perfect match: our mounting modules.



Washbasin fittings and exposed fittings

Water-saving, hygienic, robust, durable and also beautiful to look at – the washbasin fittings and exposed fittings from SCHELL are truly a cut above the rest. Available in a wide range of different technical designs.



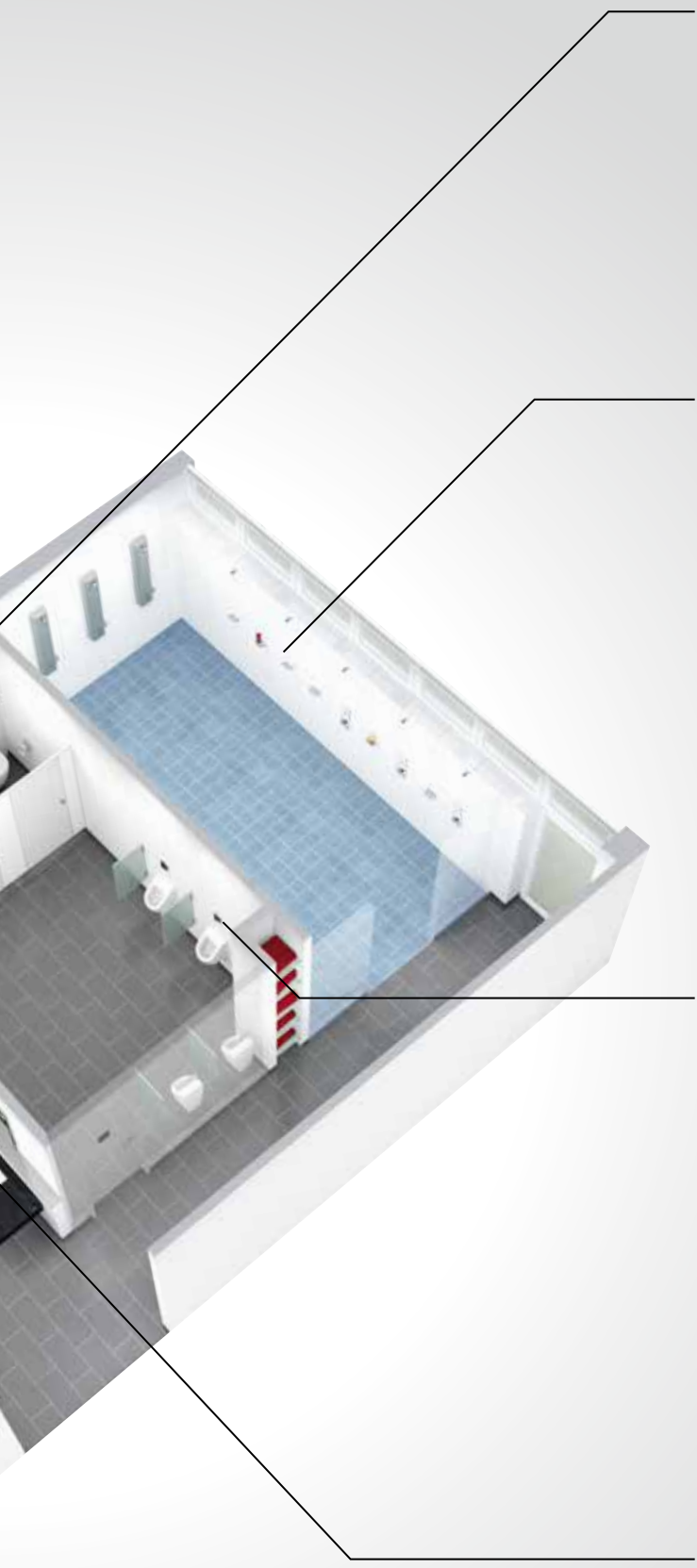

Montus modules

SCHELL offers a complete range of mounting modules. Included are models suitable for drywall and masonry installation that offer compliance with DIN 4109 (sound insulation in structural engineering) and plenty of innovative details.



Shower fittings/shower panels

Showers in public, semi-public and commercial sanitary facilities are in constant use. For both new building and refurbishment projects, the high-quality materials and well thought-out design contribute to durability, economical water use and the trouble-free operation of our shower fittings and panels, even in these demanding conditions.



Urinal flush systems

As exposed or concealed installations they are much in demand: the water-saving and hygienic urinal flushing systems from SCHELL. Available in mechanical and electronic designs that make them not only suitable for new-build work but the ideal choice for quick and easy retrofitting in refurbishment projects. Urinal flushing systems from SCHELL: combined with our mounting modules, they are the perfect all-round solution.



Angle valves

There's plenty of great things in store from Europe's market leader for angle valves, including water-saving functions, exceptional quality, attractive designs and the most extensive range for all applications. Available with an integrated back-flow preventer or filter, as required, almost every model meets noise class I.



Good reasons for using SCHELL shower fittings.

What you should know.



Public shower facilities pose special challenges in relation to hygiene, materials and water consumption.



Attractive designs, sustainable water consumption and good hygiene: SCHELL shower fittings

Whether in schools, fitness centres or hotels – shower fittings in public, semi-public and commercial buildings must satisfy particular demands (unlike those in private sanitary facilities). As a specialist in these application areas, SCHELL has built up an excellent global reputation. The latest proof of uncompromising SCHELL quality is the awarding of the new European efficiency label 'WELL' to several SCHELL fittings. SCHELL also has economical shower fittings, of course, and so the first WELL classifications have already been applied for.

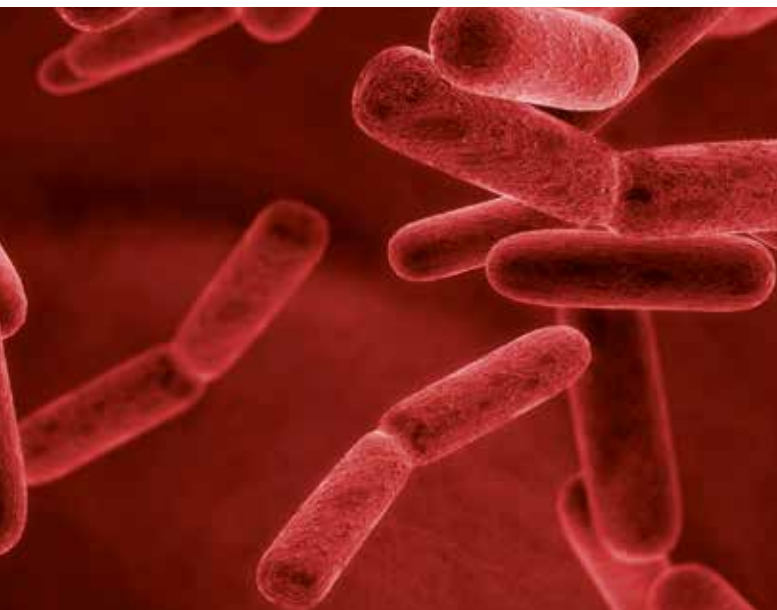

Rod-shaped bacteria:
much less of a risk factor with start-of-the-art SCHELL technology.

Robust materials

SCHELL prides itself on the exclusive use of high-quality, robust materials. As one example, all functional components are made from high-performance plastics. The fitting bodies are made from dezincification-resistant brass in accordance with drinking water legislation and are well-protected in wall boxes for our concealed solutions. The corresponding SCHELL front panels are available in brass with a chrome finish or are made from stainless steel. Our shower panels are made from solid, corrosion-protected extruded aluminium sections with an anodised and polished, easy-to-clean surface, and can handle even the roughest day-to-day use.

Water-saving technologies

SCHELL can offer you a wide range of water-saving solutions: from single-lever fittings with rapid setting of the desired temperature to self-closing fittings with cartridge or CVD touch technology and start-stop functionality, right up to sensor-

based electronically controlled solutions. Regardless of the version you select, the objective here is to regulate the water's flow time and flow rate easily, economically and sparingly.

Stringent hygiene standards

Hygiene is especially important in public and semi-public shower facilities. Due to Legionella, for example. This is why SCHELL has become the first German manufacturer to integrate thermal disinfection technology as specified in DVGW worksheet W551 directly into the fitting bodies. The opened solenoid valve ensures the flow of water at 70°C (3 minutes flush time according to W551) and therefore the elimination of dangerous bacteria. To prevent water stagnating in pipelines, for example, our fittings with CVD touch electronics trigger a flow of water for 20 seconds no later than every 24 hours after the last use. And we've even made sure that the smooth, rounded edges of our fittings are easy to clean and have minimal contact areas for accumulating dirt.

Attractive design

For many years, SCHELL has proven that even fittings technology in public sanitary facilities can meet high standards in terms of aesthetics. The design language is clear-cut and the materials are of a high quality. The front panels of our concealed fittings have low installation depths and slightly rounded external contours.

SCHELL system solutions: the future is digital. Even in public sanitary facilities.

SCHELL SWS Water Management System

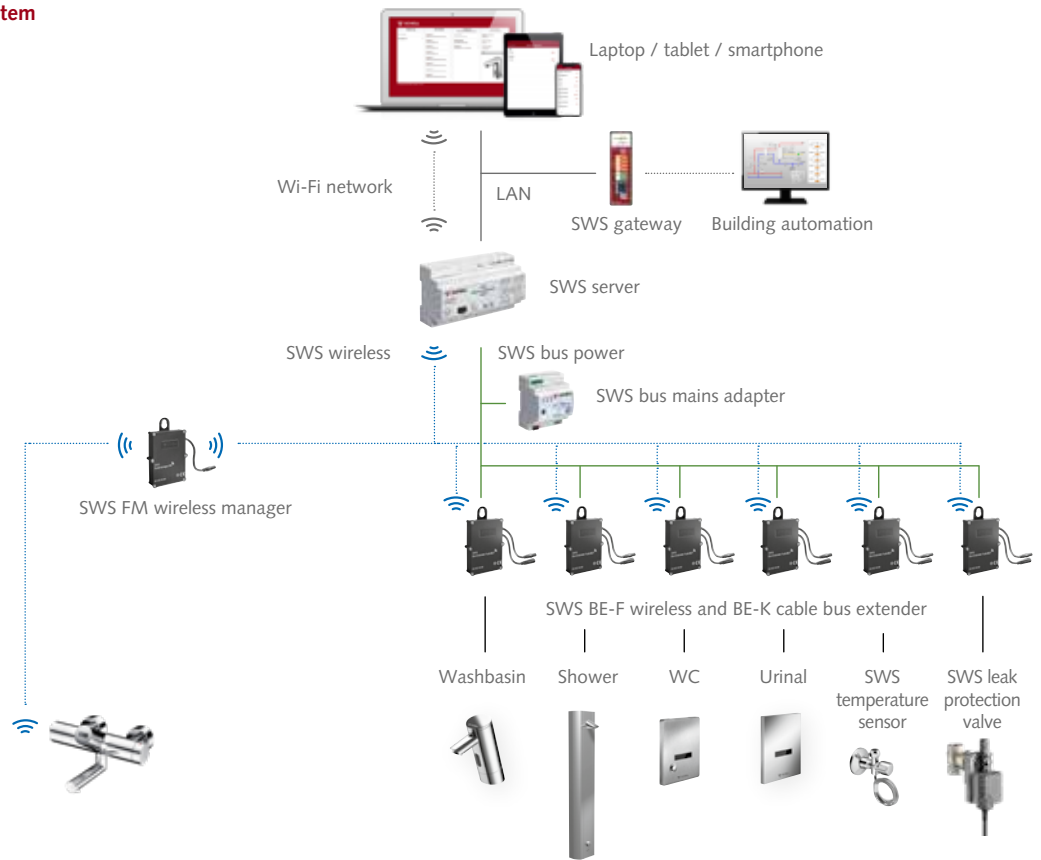

SCHELL Single Control SSC Bluetooth® module



SCHELL system solutions usher in a new era for facility management in public buildings. From the parameterisation of individual electronic fittings to the central, server-based control system for all installations, efficient user comfort is assured at all times with digital solutions from SCHELL.

SCHELL Water Management System SWS

The water management system is primarily designed for maintaining water quality in larger buildings with a large number of fittings – and with sensors as required. In this system, all electronic fittings and sensors are networked using a wired or wireless network and managed by one or more central servers.



SCHELL Single Control SSC Bluetooth® module

The SSC Bluetooth® module has been designed for use in buildings with only a few electronic fittings. It enables wireless communication between a smartphone and a fitting. The module can be either permanently or temporarily connected to the fitting.



Concealed shower fittings. By SCHELL.

A wonderfully simple system.

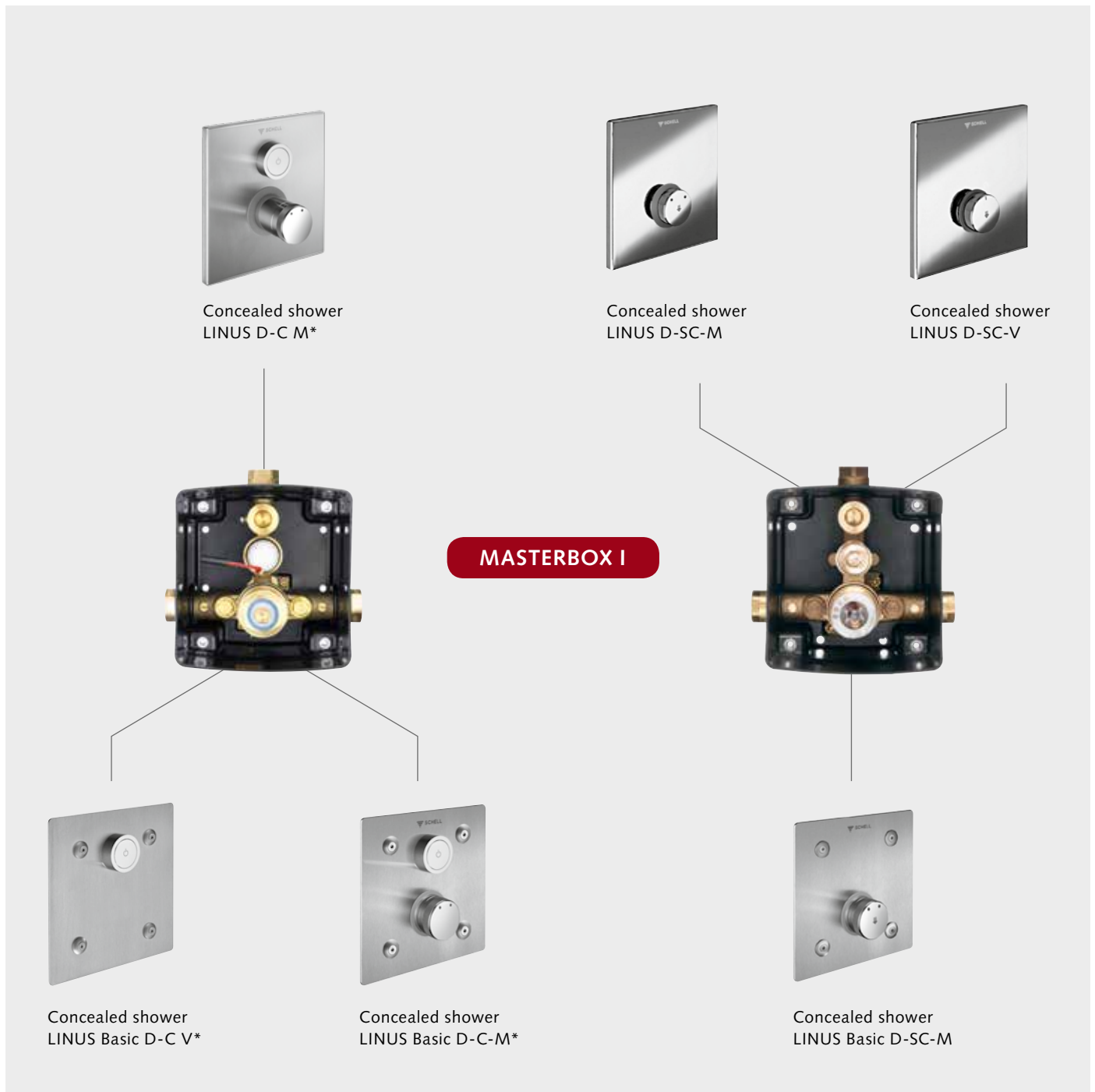

Why make things complicated? SCHELL concealed shower fittings are the perfect example. The technical base system here is made up of just two components – the masterbox (where the fitting is pre-assembled at the factory) and the prefabricated set (made up of a front panel with corresponding operating controls). Various versions of the masterbox are available, depending on the type of water supply (e.g. mixed or pre-mixed water) and the operating functions required (e.g. self-closing or CVD touch electronics). The range is completed by two shower head styles and the MONTUS mounting module. An overview of all of the versions can be found on page 18/19.

*Parameters can be set easily even for individual fittings, with the SCHELL Single Control SSC Bluetooth® module and the free app developed by SCHELL for use with iOS and Android.



Concealed shower
LINUS D-C-T 1)



Concealed shower
LINUS D-SC-T



MASTERBOX II



Concealed shower
LINUS Basic D-C-T 1)2)



Concealed shower
LINUS Basic D-SC-T

Accessories



1) Can be networked with the SCHELL SWS Water Management System



2) Parameter setting possible with SCHELL SSC



SCHELL shower head
COMFORT
Item no. 01 845 06 99



SCHELL shower head
soft-stream
Item no. 01 814 06 99



Shower module
MONTUS
Item no. 03 257 00 99

The entry-level solution for concealed shower fittings.
LINUS Basic D-SC and LINUS Basic D-C.



LINUS Basic D-SC-T

With the LINUS Basic range, SCHELL is able to offer a solution that includes the many advantages of intelligent fitting technologies – even at minimal levels of investment. The range is characterised by solid, functional, uncompromising products. Best of all, it is available in three different versions and at an especially attractive price.



LINUS Basic D-C-T

LINUS Basic D-C-T is the prefabricated set for electronic self-closing fittings with splashproof CVD touch electronics and a pressure-sensitive actuating element.

Product features

- CVD touch electronics ON/OFF/timer
- Stainless steel front panel
- Thermostatic temperature control
- Flow time can be set from 10 to 360s in 10 program steps
- Flow rate: max. 15.0 l/min at 3 bar
- Selectable 24-hour stagnation flush
- Thermostat operation with hot water stop at 38 °C
- Locking disc for maximum temperature limit (anti-scalding protection)
- Thermal disinfection can be retrofitted
- Operating panel made from chrome-plated brass
- Mains- or battery-operated
- Noise class: I

LINUS Basic D-SC-T, the prefabricated set for self-closing fittings with state-of-the-art SCHELL cartridge technology

Product features

- Stainless steel front panel
- SC II self-closing cartridge
- Thermostatic temperature control
- Adjustable flow time (5 to 30s)
- Flow rate: max. 15.0 l/min at 3 bar
- Thermostat operation with hot water stop at 38 °C
- Locking disc for maximum temperature limit (anti-scalding protection)
- Thermal disinfection can be retrofitted
- Low-maintenance, thanks to self-cleaning nozzle orifice
- Operating panel made from chrome-plated brass
- Noise class: I

LINUS Basic D-SC-M, the prefabricated set for self-closing fittings with state-of-the-art SCHELL cartridge technology

Product features

- Stainless steel front panel
- SC II self-closing cartridge
- Adjustable flow time (5 to 30s)
- Flow rate: max. 15.0 l/min at 3 bar
- Low-maintenance, thanks to self-cleaning nozzle orifice
- Operating panel made from chrome-plated brass
- Noise class: I



Self-closing concealed shower fittings.

LINUS D-SC-T, LINUS D-SC-M, LINUS Basic D-SC-M, LINUS D-SC-V.



The traditional solutions from SCHELL, which leave nothing to be desired when it comes to manual shower heads: high-quality, robust and beautiful. A trusted solution for many years – whether in schools, sports centres or hotels.



LINUS D-SC-T



LINUS D-SC-M/LINUS Basic D-SC-M/
LINUS D-SC-V

A bevy of benefits

- Reliable technology
- SC cartridge with fine-grained flow time adjustment
- Requires no external energy source (e.g. battery or 230 V mains supply)
- Economical water consumption
- User-friendly operation
- Virtually vandal-proof
- Appealing design

Versions

- **LINUS D-SC-T**, the prefabricated set for self-closing fittings with thermostat
- **LINUS D-SC-M/ LINUS Basic D-SC-M**, the prefabricated set for self-closing fittings using mixed water
- **LINUS D-SC-V**, the prefabricated set for self-closing fittings using pre-mixed water

Product features

- Temperature regulation with hot water limiter (LINUS D-SC-M)
- Thermostatic temperature control with locking disc for maximum temperature limit (anti-scalding protection)
- Flow rate: max. 15.0l/min at 3 bar
- Water temperature max. 70 °C (short-time-use)
- Available with chrome or stainless steel surface
- Operating panel made from chrome-plated brass
- Noise class: I
- Flow time setting: 5–30 s (LINUS D-SC-M, D-SC-V, D-SC-T)
- Flow pressure: 1.5–5.0 bar

Electronic concealed shower fittings. LINUS D-C.



The innovation solutions from SCHELL: user-friendly, water-saving and – thanks to stagnation flush and thermal disinfection – especially hygienic. Their clear-cut design and high-quality materials perfectly complement any bathing facility.



Especially hygienic thanks to a selectable stagnation flush:
the LINUS D-C-M and LINUS D-C-T models

Shower fittings from SCHELL promise you a totally new showering experience.

Versions

- **LINUS D-C-T**, the CVD-controlled shower fitting prefabricated set with thermostat
- **LINUS Basic D-C-T**, the CVD-controlled shower fitting prefabricated set with thermostat
- **LINUS D-C-M**, the compact, CVD-controlled shower fitting prefabricated set (mixer)
- **LINUS Basic D-C-M**, the CVD-controlled shower fitting prefabricated set (mixer)
- **LINUS Basic D-C-V**, the CVD-controlled shower fitting prefabricated set for pre-mixed water

Product features







- Flow rate: max. 15.0 l/min at 3 bar
- Hygienic flush can be activated 24 hours after last use (LINUS D-C-T, LINUS Basic D-C-T, LINUS D-C-M, LINUS Basic D-C-M, LINUS Basic D-C-V)
- Water temperature max. 70°C (short-time-use)
- Thermostat fittings: thermostatic valve temperature control and hot water stop at 38°C
- Locking disc for maximum temperature limit (anti-scalding protection)
- LINUS front panel made from chrome-plated brass or stainless steel
- Noise class: I
- Flow pressure: 1.5–5.0 bar
- Flow time settings: 10–360s in 10 program steps (LINUS D-C-T, LINUS Basic D-C-T, LINUS D-C-M, LINUS Basic D-C-M, LINUS Basic D-C-V)



















Concealed shower fittings at a glance.

One system. Many solutions.

Manual operation

Self-closing

| Manual operation | | | | |
|-----------------------------------|-----------------------------------------------------------------------------------|-----------------------------------------------------------------------------------|-------------------------------------------------------------------------------------------------------------------------|---------------------------------------------------------------------------------------------------------|
| Self-closing | | | | |
| |  |  |  |  |
| LINUS D-SC-M | LINUS Basic D-SC-M | LINUS D-SC-V | LINUS D-SC-T | LINUS Basic D-SC-T |
| ● 01 832 06 99 01 832 28 99 | ● 01 902 28 99 | | | |
| | | ● 01 833 06 99 01 833 28 99 | | |
| | | | ●  01 809 06 99 01 809 28 99 | ●  01 900 28 99 |
| | | | | |
| | | | | |
| | | | | |

| Electronic control | | | Matching masterbox |
|-------------------------------------------------------------------------------------------------------------------------------------------------------------------------------------------------------------------------------|--------------------------------------------------------------------------------------------------------------------------------------------------------------------------------------------------------------------------------------------------------------------------------------------------------------|-----------------------------------------------------------------------------------------------------------------------------------------------------------------------------------------------------|--------------------------------------------------------------------------------------------------------------------------------------|
| CVD touch electronics | | | |
|  <p>LINUS D-C-M LINUS Basic D-C-M LINUS Basic D-C-V</p> |  <p>LINUS D-C-T</p> |  <p>LINUS Basic D-C-T</p> | |
| | | |  <p>Masterbox WBD-SC-M 01 867 00 99</p> |
| | | |  <p>Masterbox WBD-SC-V 01 827 00 99</p> |
| | | |  <p>Masterbox WBD-SC-T 01 800 00 99</p> |
|   <p>01 919 06 99 01 919 28 99 01 920 28 99</p> | | |  <p>Masterbox WBD-E-M 01 904 00 99</p> |
| |    <p>01 918 06 99* 1)2) 01 918 28 99* 1)2)</p> |   <p>01 909 28 99* 1)2)</p> |  <p>Masterbox WBD-E-T 01 802 00 99</p> |
|   <p>01 921 28 99</p> | | |  <p>Masterbox WBD-E-V 01 822 00 99</p> |



1) Can be networked with the SCHELL SWS Water Management System



2) Parameter setting possible with SCHELL SSC



Selectable stagnation flush every 24 hours for approx. 20 seconds

Exposed shower fittings.

VITUS with shower connection at top/bottom.



The VITUS series offers a unique and modular range of fittings from SCHELL that are versatile, user-friendly and hygienic. The exposed shower fitting and wide range of accessories makes renovating and upgrading shower facilities quick and easy.

Less is more. Efficiency plus safety from SCHELL.

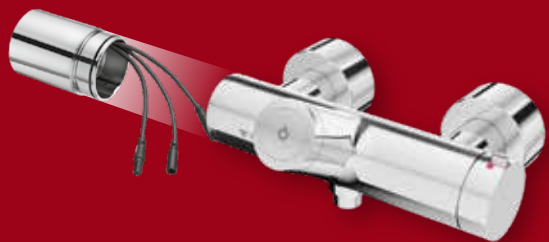

The Bluetooth® module is available as an upgrade kit for all VITUS fittings and even offers thermal disinfection as an optional extra.

VITUS is a unique and modular range of fittings that is available for use as an exposed shower fitting in a wide variety of different designs. Whether for mixed water or with a thermostat, and with manual, self-closing or electronic actuation. We have focused in particular on user and drinking water hygiene. Some designs offer a stagnation flush. All variants also offer the option of thermal disinfection (manual flush valve for retrofitting or pre-installed at the factory). Other quality criteria include a robust, all-metal design and maximum user hygiene – and these criteria also helped VITUS to win the 'Plus X Award' innovation prize.

Other key features in terms of hygiene: the easy-to-clean, smooth chrome surfaces, the lockable S-connections and the fact that the union nuts are covered by the rosette.

Thermal disinfection. Legionella bacteria are an important issue, especially in shower areas in public sanitary facilities. And VITUS has the right solution for this, too: thermal disinfection. This makes it possible to meet the requirements of the DVGW worksheet W551 for thermal disinfection with hot water at 70 °C for 3 minutes. This ensures that the potable water heater and the whole warm water system – including draw-off fittings – can therefore be rinsed at more than 70 °C for at least 3 minutes. SCHELL also provides VITUS fittings with a pre-assembled valve for thermal disinfection. If required, the valve can also be retrofitted at any time.

Conforming to intended use with a selectable stagnation flush. To provide hygienically acceptable drinking water, any extended stagnation of the water flow must be avoided in pipes at all times. If regular use of the system cannot be guaranteed, a stagnation flush can be activated by means of the new CVD touch electronics. The CVD touch electronics unit is a particularly robust, touch-sensitive control that has been developed specifically to meet the special requirements in public, semi-public and commercial sanitary facilities. This unit opens up new possibilities for an even more efficient and safer stagnation flush. This is because stagnation intervals and flush times can now be comfortably, individually and clearly adjusted with the SCHELL SWS software. Extensive diagnostic functions are also available.



SCHELL SWS



SCHELL SSC

SCHELL system solutions

The SCHELL exposed shower fitting VITUS VD-C-T is SCHELL SWS- and SCHELL SSC-ready. This not only means that it can simply be used 'out of the box' but also operated with appropriate accessories vis SWS and have its parameters configured via SSC.





Product overview.
Shower fittings VITUS.



Since no two public sanitary facilities are the same, their requirements and operating models are also as individual as they are. VITUS offers property developers and users everything they want and need while providing a wide range of options for actuating the flow of water.

System overview.

VITUS shower fittings.

| |  |  |  |  |  |
|-------------------------------------|-------------------------------------------------------------------------------------------------------------------------------------------------------------|-------------------------------------------------------------------------------------------------------------------------------------------------------------|-------------------------------------------------------------------------------------------------------------------------------------------------------------|--------------------------------------------------------------------------------------------------|----------------------------------------------------------------------------------------|
| Connection at top | | | | | |
| Without thermal disinfection | 01 604 06 99 | 01 600 06 99 | 01 602 06 99 | 01 601 06 99 | 01 603 06 99 |
| Manual thermal disinfection | 01 609 06 99 | 01 605 06 99 | 01 607 06 99 | 01 606 06 99 | 01 608 06 99 |
| Connection at bottom | | | | | |
| Without thermal disinfection | 01 614 06 99 | 01 610 06 99 | 01 612 06 99 | 01 611 06 99 | 01 613 06 99 |
| Manual thermal disinfection | 01 619 06 99 | 01 615 06 99 | 01 617 06 99 | 01 616 06 99 | 01 618 06 99 |
| | VITUS VD-C-T ^{1) 2)} | VITUS VD-SC-T | VITUS VD-On/Off-T | VITUS VD-SC-M | VITUS VD-EH-M |
| Function | CVD button On/Off/Timer Thermostat | Self-closing On/Off/Timer Thermostat | Rotary knob On/Off Thermostat | Self-closing On/Off/Timer Mixed water | Single lever On/Off Mixed water |
| Flow time | Flow time setting from 10 to 360s in 1s increments | Flow time setting from 10 to 30s in 1s increments | | Flow time setting 10 to 30s | |
| Switching on | Fingertip | Pushbutton operation | Rotary knob operation | Pushbutton operation | Single-level operation |
| Switching off | With button press Automatic water stop when set flow time set has expired. | Self-closing | Rotary knob operation | Self-closing | Single-level operation |
| Temperature control | Precise temperature control by thermostat with hot water stop at 38°C Locking disc for maximum temperature limit (anti-scalding protection) | Precise temperature control by thermostat with hot water stop at 38°C Locking disc for maximum temperature limit (anti-scalding protection) | Precise temperature control by thermostat with hot water stop at 38°C Locking disc for maximum temperature limit (anti-scalding protection) | Mixed control using an actuation handle with option to limit hot water volume | Mixed control using an actuation handle with option to limit hot water volume |
| Drinking water hygiene | Option for performing thermal disinfection. Stagnation flush program. 2x backflow preventer | Option for performing thermal disinfection. 2x backflow preventer | Option for performing thermal disinfection. 2x backflow preventer | Option for performing thermal disinfection. 2x backflow preventer | Option for performing thermal disinfection. 2x backflow preventer |
| Mains-operated | Battery-operated | | | | |
| Design | Electronic with bistable solenoid valve Shower connection: top/bottom | Self-closing cartridge made from corrosion-proof plastic, shower connection: top/bottom | Shower connection: top/bottom | Self-closing cartridge made from corrosion-proof plastic, shower connection: top/bottom | Shower connection: top/bottom |
| Particularly suitable for: | fittings in systems with particular requirements for convenience, design and hygiene (Legionella switching) | Cost-effective solution for public facilities | Solution with thermostat Shower user determines flow time | Cost-effective solution for public facilities | Cost-effective solution Shower user determines flow time |

All fittings suitable for use with drinking water pursuant to the 2001 German Drinking Water Ordinance as amended in 2013. Special applications on request. Please observe the "SCHELL General Installation Conditions." (www.schell.eu)

1) Can be networked with SCHELL Water Management System SWS 2) Parameter setting possible with SCHELL SSC



A perfect combination. **VITUS shower fittings and accessories.**

Thanks to its modular construction, VITUS is able to offer a matching shower solution for almost any sanitary facility. VITUS can be supplied with either a top or bottom outlet.

A wall connection elbow or rigid riser can be connected to the top outlet. One benefit of this solution is that it is ideal when renovating existing shower facilities. SCHELL also offers a matching 90° wall connection elbow accessory with all connection fittings required, including a large push-on rosette. The rigid riser has a G½ socket at the top end that fits a wide range of shower heads.

SCHELL offers two different variants itself here: a soft-stream shower head as well as the new COMFORT shower head. Both feature a flow limiter of 9 l/min (pressure-independent).

When fitted with a bottom outlet, VITUS is perfect for combining with a shower set comprised of a height-adjustable shower rail, shower hose and hand shower. This is a popular solution for women's showers in particular.

COMFORT shower head

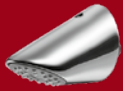

Soft-stream shower head



Outlet elbow VITUS DN 15

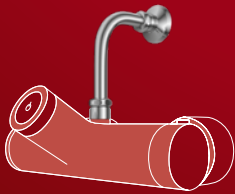

Exposed pipe set
VITUS

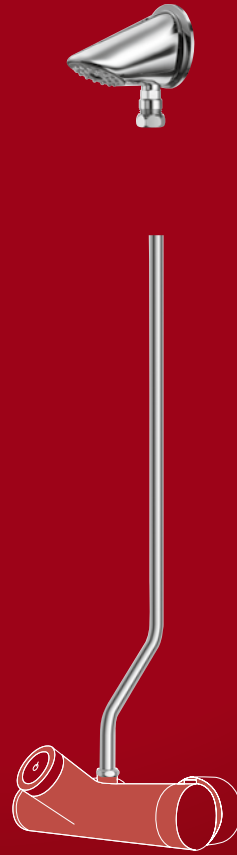

Shower set
VITUS

Hand shower
VITUS

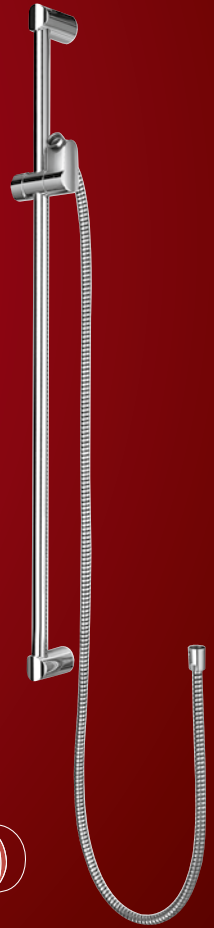

Easy-to-service design. The lockable S-connections.

SCHELL offers lockable S-connections as accessories to avoid having to shut off the entire water supply to a sanitary facility before performing service work. These are fitted under the elegant push-on rosette, making them invisible to users.

Open



Closed

Exposed shower fittings.
LINUS DP.



The practical SCHELL solution: elegant, long-lasting and easy to install. The LINUS DP shower panel combines functionality and design with simple installation. Making it the efficient answer to new-build and refurbishment projects.



LINUS DP-C-T

LINUS DP-SC-T

LINUS DP-SC-M and
LINUS DP-SC-V

LINUS DP-EH-M

The durable, corrosion-protected aluminium extruded profile with an anodised, polished, easy-to-clean surface, offers optimal visual appeal while ensuring a long service life. Even with its water-saving shower head, the user's showering comfort is not neglected. The shower panels also offer an impressive level of hygiene. The CVD control provides a selectable stagnation flush every 24 hours after the last use. In addition, DP-SC-T and DP-C-T variants can also be supplied for carrying out thermal disinfection with the monostable cartridge solenoid valve that is preassembled at the factory.

SCHELL shower panels are ready for use ex-works and fully assembled with the fitting and integrated shower head. Thanks to the mounting template, they can be installed easily by a single person. All connection lines lie protected behind the rotating front panel, which ensures rapid servicing.

Versions

- **LINUS DP-SC-M exposed shower panel**, with pre-assembled shower fitting (for mixed water)
- **LINUS DP-SC-V exposed shower panel**, with pre-assembled shower fitting (for pre-mixed water)
- **LINUS DP-SC-T exposed shower panel**, with pre-assembled shower fitting, including integrated self-closing cartridge and thermostat cartridge with safety lock if the cold water supply fails, plus hot water stop at 38 °C
- **LINUS DP-C-T exposed shower panel**, with pre-assembled shower fitting incl. splash-proof CVD touch electronics, integrated solenoid valve 6V, thermostat cartridge with safety interlock if the cold water supply fails, plus hot water stop at 38 °C

Product features

- Panel made from anodised extruded aluminium section
- Selectable stagnation flush (LINUS DP-C-T)
- Thermal disinfection
- Thermostat cartridge, anti-scalding protection
- Water supply line made from dezincification resistant brass in accordance with drinking water legislation
- Operating panel made from chrome-plated brass
- Soft-stream shower head: 9l/min (pressure-independent)
- Water temperature max. 70 °C (short-time-use)
- Flow time setting on DP-SC versions: 5–30 s
- Flow time setting on DP-C-T: 10 to 360 s in 10 program steps
- Noise class: I
- Can be supplied with COMFORT shower head or soft-stream shower head

Exposed shower fittings at a glance. Attractive and functional.

Function: Electronics (thermostat)



Exposed shower panel LINUS DP-C-T

Shower panel made from durable extruded aluminium section with a high-quality, anodised surface and integrated SCHELL shower fitting, type:

LINUS D-C-T

For easy parametrisation of the CVD touch electronics, as well as diagnostics, SCHELL offers a USB adapter and the SCHELL SWS software.

Product features

- Shower head flow rate: 9.0l/min (pressure-independent)
- Fitting flow rate: max. 15.0l/min at 3 bar flow pressure
- Flow pressure: 1.5 - 5.0bar
- Max. water temperature 70 °C (short-time-use)
- Flow time setting of 10 to 360s in 10 program steps
- Stagnation flush, 24 hours after last use, selectable
- Dimensions in mm: 1200 × 226 × 115
- Panel is ready for connection to existing wall-mounted connections from the rear and wall-mounted supply lines from above
- Noise class: I
- Certification mark: P-IX 18001/IA

Prepared for operation with SCHELL universal battery compartment or SCHELL universal mains adapters

**LINUS DP-C-T
with COMFORT shower head
Item no. 00 819 08 99**

**LINUS DP-C-T
with soft-stream shower head
Item no. 00 822 08 99**

With preassembled, monostable 12V solenoid valve for thermal disinfection

**With COMFORT shower head
Item no. 00 820 08 99**

**With soft-stream shower head
Item no. 00 823 08 99**

Function: Self-closing (thermostat)

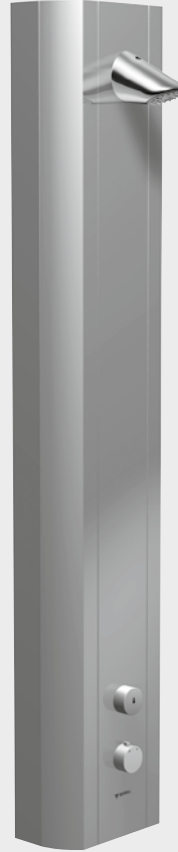

Exposed shower panel LINUS DP-SC-T

Shower panel made from durable extruded aluminium section with a high-quality, anodised surface and integrated SCHELL shower fitting, type:

LINUS D-SC-T

Product features

- Shower head flow rate: 9.0l/min (pressure-independent)
- Fitting flow rate: max. 15.0l/min at 3 bar flow pressure
- Flow pressure: 1.5 - 5.0bar
- Max. water temperature 70 °C (short-time-use)
- Flow time setting: 5 - 30 s
- Dimensions in mm: 1200 × 226 × 115
- Panel is ready for connection to existing wall-mounted connections from the rear and wall-mounted supply lines from above
- Noise class: I
- Certification mark: P-IX 18001/IA

**LINUS DP-SC-T
with COMFORT shower head
Item no. 00 802 08 99**

**LINUS DP-SC-T
with soft-stream shower head
Item no. 00 824 08 99**

With preassembled, monostable 12V solenoid valve for thermal disinfection

**With COMFORT shower head
Item no. 00 815 08 99**

**With soft-stream shower head
Item no. 00 825 08 99**



Can be networked with the SCHELL Water Management System SWS



Parameter setting possible with SCHELL SSC

Function: Self-closing (mixed water)



Exposed shower panel LINUS DP-SC-M

Shower panel made from durable extruded aluminium section with a high-quality, anodised surface and integrated SCHELL shower fitting, type: LINUS D-SC-M

Product features:

- Shower head flow rate: 9.0l/min (pressure-independent)
- Fitting flow rate: max. 15.0l/min at 3 bar flow pressure
- Flow pressure: 1.5 - 5.0 bar
- Max. water temperature 70 °C (short-time-use)
- Flow time setting: 5 - 30s
- Dimensions in mm: 1200 × 226 × 115
- Panel is ready for connection to existing wall-mounted connections from the rear and wall-mounted supply lines from above
- Noise class: I
- Certification mark: P-IX 18008/IA

LINUS DP-SC-M
with COMFORT shower head
Item no. 00 803 08 99

LINUS DP-SC-M
with soft-stream shower head
Item no. 00 826 08 99

Function: Self-closing (pre-mixed mixed water)



Exposed shower panel LINUS DP-SC-V

Shower panel made from durable extruded aluminium section with a high-quality, anodised surface and integrated SCHELL shower fitting, type: LINUS D-SC-V

Product features

- Shower head flow rate: 9.0l/min (pressure-independent)
- Fitting flow rate: max. 15.0l/min at 3 bar flow pressure
- Flow pressure: 1.5 - 5.0 bar
- Max. water temperature 70 °C (short-time-use)
- Flow time setting: 5 - 30s
- Dimensions in mm: 1200 × 226 × 115
- Panel is ready for connection to existing wall-mounted connections from the rear and wall-mounted supply lines from above
- Noise class: I
- Certification mark: P-IX 18008/IA

LINUS DP-SC-V
with COMFORT shower head
Item no. 00 804 08 99

LINUS DP-SC-V
with soft-stream shower head
Item no. 00 827 08 99

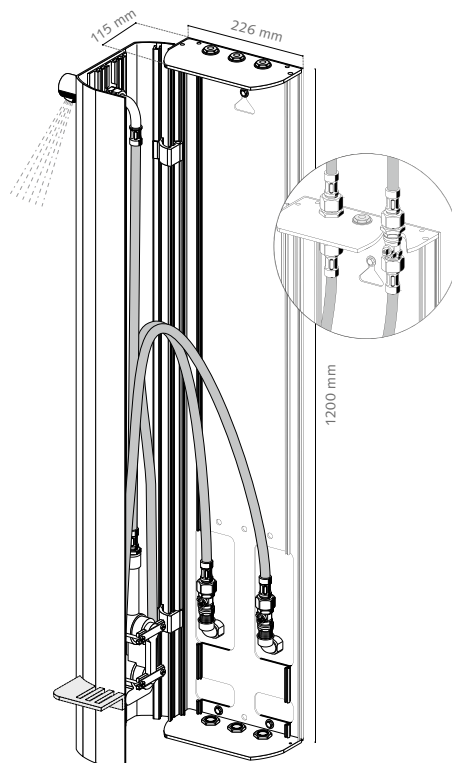

Installation and maintenance made easy

- All pre-assembled connection lines lie protected behind the rotating front panel, which ensures straightforward servicing and simple installation by a single fitter.
- The panel can be connected from behind or from above, e.g. for renovation projects with an existing wall-mounted pipe conduit.

Exposed shower fittings at a glance. Attractive and functional.

Function: Single-lever mixer (mixed water)



Exposed shower panel

LINUS DP-EH-M

Shower panel made from durable extruded aluminium section with a high-quality, anodised surface and integrated SCHELL shower fitting, type: LINUS D-EH-M

Field of application/technical data:

- Shower head flow rate:
9.0l/min (pressure-independent)
- Fitting flow rate: max. 10.0l/min
at 3 bar flow pressure
- Flow pressure: 1.5 - 5.0 bar
- Max. water temperature 70 °C
(short-time-use)
- Panel is ready for connection to existing wall-mounted connections from the rear and wall-mounted supply lines from above

LINUS DP-EH-M

with COMFORT shower head
Item no. 00 828 08 99

With pre-assembled LINUS EH-M shower fitting and integrated ceramic cartridge, including piping between fitting and shower head connection

Made in Olpe. In demand worldwide.

A hygiene solution from SCHELL is increasingly the product of choice for planners, architects, installers and property developers – for new buildings and renovations, for stadiums, universities, hotels and swimming baths. SCHELL's uncompromising, 'Made in Germany' quality sets the highest of standards when it comes to optimum drinking and process water hygiene. And it does so all over the world.

Here are just a few examples:

- 1 Camping Le Brasilia, Canet en Roussillon
- 2 Leisure pool, Olpe
- 3 Continental Arena, Regensburg
- 4 Fitness club PURE, Kornwestheim
- 5 University of Duisburg-Essen
- 6 Holiday Inn, Nice

Additional references are available from www.schell.eu





SCHELL GmbH & Co. KG
Armaturentechnologie
Raiffeisenstraße 31
57462 Olpe
Germany
Tel. +49 2761 892-0
Fax +49 2761 892-199
info@schell.eu
www.schell.eu

